

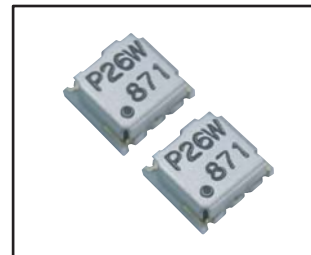

WIMAX

電圧可変位相器
Voltage Variable Phase Shifter



形状寸法 Configuration, Dimensions

Unit : mm

VVP542L-2600W-G

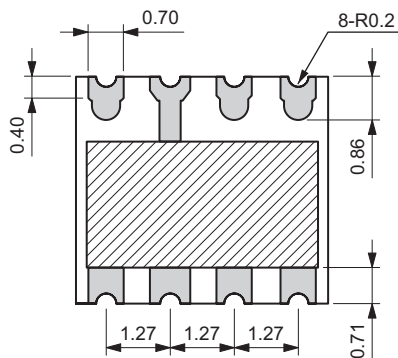
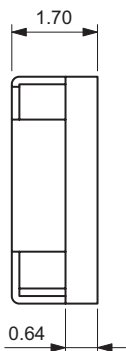
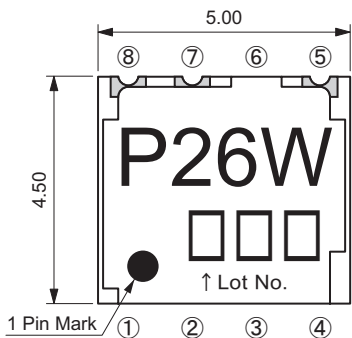

- ① GND
- ② GND
- ③ GND
- ④ GND
- ⑤ RF 2 (OUT)
- ⑥ GND
- ⑦ Vcont
- ⑧ RF 1 (IN)

使用はんだ : RoHS対応

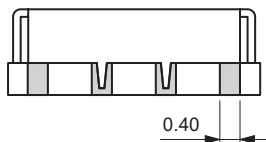

：オーバークラス

仕様 Specifications

製品番号 Style No.	周波数範囲 Frequency Range [MHz]	挿入損失 Insertion Loss [dB]	最大制御電圧 Max. Voltage [V]	最大入力電力 Max. Input Power [mW]	制御電圧範囲 Vcont Range [V]	位相可変量 Phase Shift [deg.]	VSWR	位相偏差 Phase Flatness [deg.]	IM3 [dBc] +5dBm 2 tone Ave.
VVP542L-2600W-G	2500~2700	2.8 max.	30 max.	100 max.	0~15	110 min.	1.5 max.	± 5.0	-60 max.

使用温度範囲 -20 ~ +85 °C Working Temperature Range -20 ~ +85 °C

推奨パッド寸法 Recommendable Footprint

Unit : mm

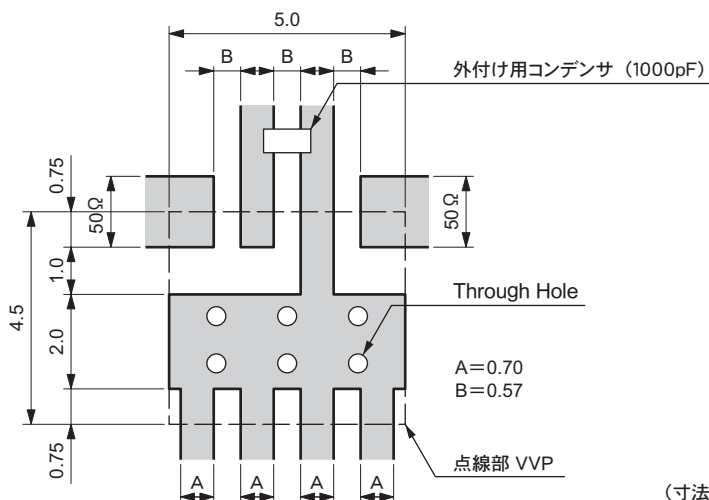

(寸法公差 ±0.1)

★製品仕様は、改良のため変更することがあります。Specifications of products are subject to change without notice.

vvp542l-p01-01



株式会社 MKT TAISEI

【本社】〒171-0021 東京都豊島区西池袋5-16-2 タケウチビル
TEL: (03) 3982-0029 (代) FAX: (03) 3986-1537 E-mail: info@mkt-taisei.com
【関西営業所】〒532-0011 大阪市淀川区西中島3-18-9 新大阪日大ビル513
TEL: (06) 6390-7264 FAX: (06) 6390-6945 E-mail: mkt-k@wonder.ocn.ne.jp

MKT TAISEI Co.,Ltd.

【Head Office】5-16-2, Nishi-Ikebukuro, Toshima-ku, Tokyo, 171-0021, Japan.
PHONE: +81-3-3982-0029 FAX: +81-3-3986-1537 E-mail: info@mkt-taisei.com
【Kansai Branch】3-18-9, Nishi-Nakajima, Yodogawa-ku, Osaka-City, 532-0011, Japan.
PHONE: +81-6-6390-7264 FAX: +81-6-6390-6945 E-mail: mkt-k@wonder.ocn.ne.jp



WiMAX

電圧可変位相器
Voltage Variable Phase Shifter

特性例 *Typical Performance*

at 25°C

VVP542L-2600W-G

Control Voltage VS Insertion Loss

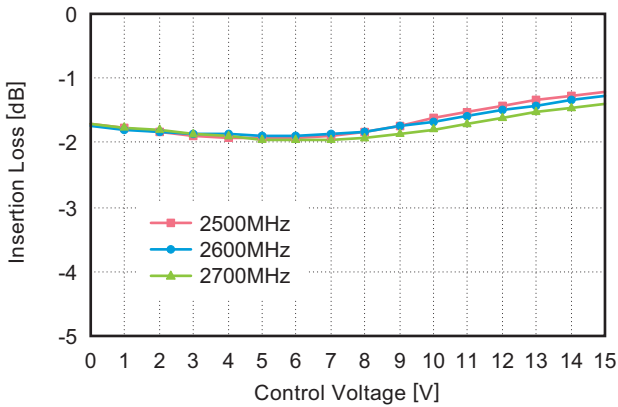

Control Voltage VS Return Loss (S11)

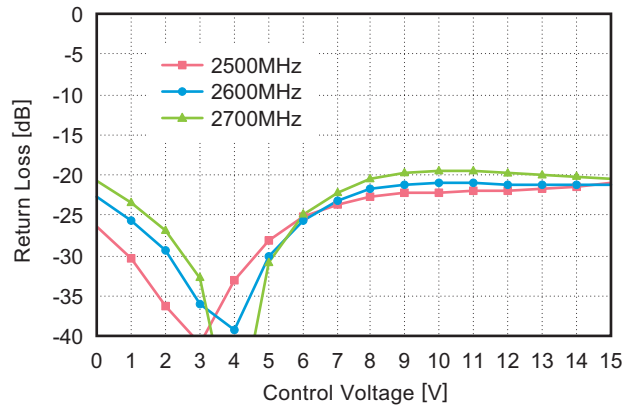

Control Voltage VS Return Loss (S22)

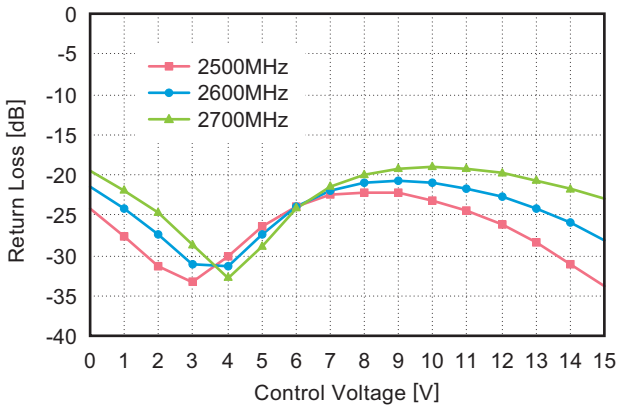

Control Voltage VS Phase

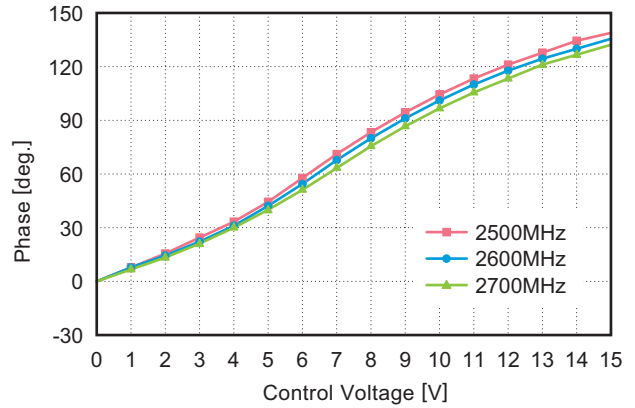

Frequency VS Insertion Loss

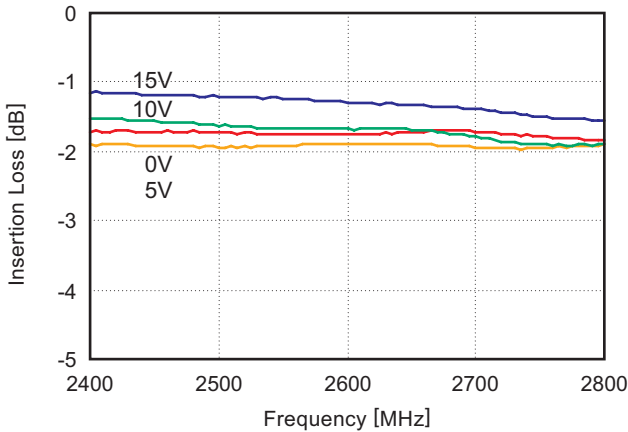

Frequency VS Phase

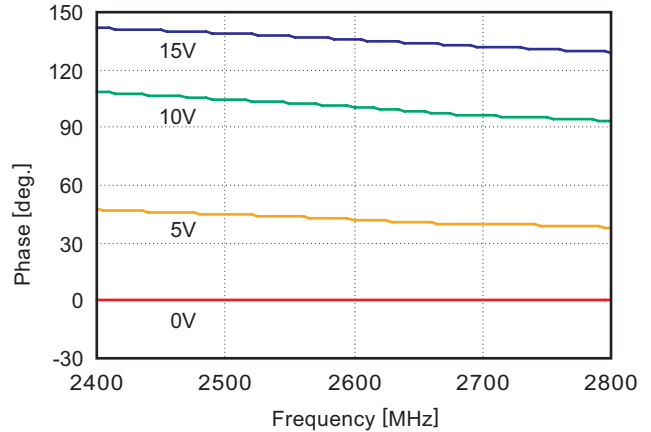

★製品仕様は、改良のため変更することがあります。Specifications of products are subject to change without notice.

vvp542l-p02-01



株式会社 **MKT TAISEI**

【本社】〒171-0021 東京都豊島区西池袋5-16-2 タケウチビル
TEL: (03) 3982-0029 (代) FAX: (03) 3986-1537 E-mail: info@mkt-taisei.com
【関西営業所】〒532-0011 大阪府淀川区西中島3-18-9 新大阪日大ビル513
TEL: (06) 6390-7264 FAX: (06) 6390-6945 E-mail: mkt-k@wonder.ocn.ne.jp

MKT TAISEI Co.,Ltd.

【Head Office】5-16-2, Nishi-Ikebukuro, Toshima-ku, Tokyo, 171-0021, Japan.
PHONE: +81-3-3982-0029 FAX: +81-3-3986-1537 E-mail: info@mkt-taisei.com
【Kansai Branch】3-18-9, Nishi-Nakajima, Yodogawa-ku, Osaka-City, 532-0011, Japan.
PHONE: +81-6-6390-7264 FAX: +81-6-6390-6945 E-mail: mkt-k@wonder.ocn.ne.jp