

- ★ A wide option of size in each part and spring force are fully provided with our probes and receptacles.
- ★ A full variation for materials, finish, and projection quantity of our probes are also supplied.

### STANDARD SPECIFICATION

Stroke	3.0 mm	
Spring Force	0.382 N	Preload
	0.981 N	Recommended Travel (2/3)
Max. Current	5 A	
Contact Resistance	30 mΩ	Probe

### STANDARD MATERIALS / FINISH

Parts Name	Materials	Finish
Plunger	S K	Ni-Base Rh Plated
Barrel	B S	Ni-Base Au Plated
Spring	S U S	
Receptacle	B S	Ni-Base Au Plated

### RECEPTACLE SHAPE

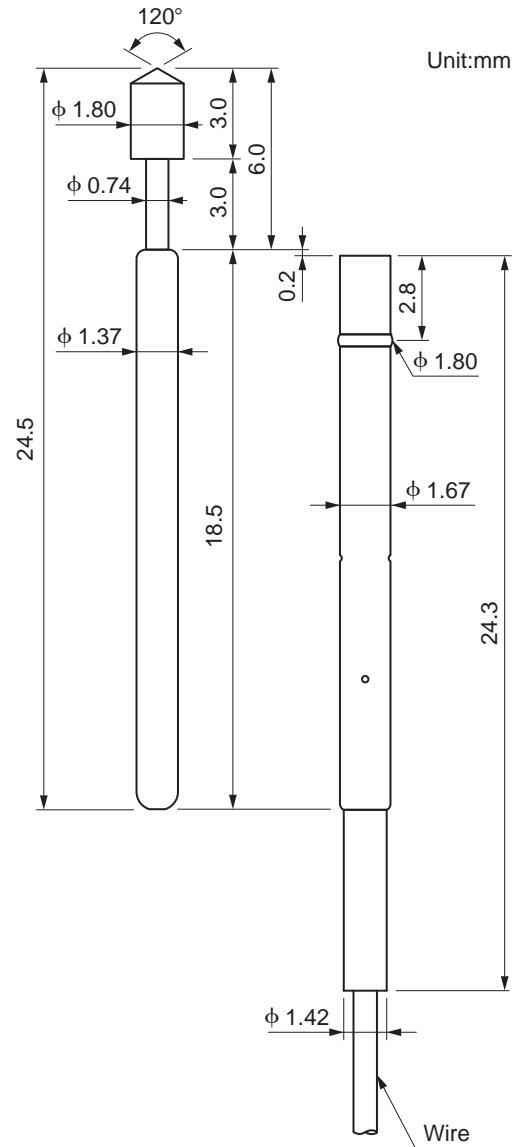
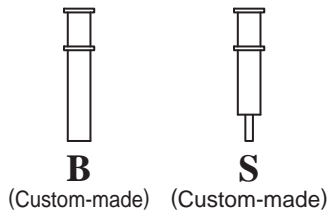

### HOW TO CODE FOR RECEPTACLE PRODUCTS

RT137 - GA00 - \*\*\*

①	②	③	④
① Outer Shape Refer to "RECEPTACLE SHAPE CODE"	② Wire A Wireless R Red	③ Serial No. Tracing No.	④ Wire Length Unit : mm

- In case of the socket with wire, please specify the length of wire and it's stripped length.
- All specifications are subject to change without notice.

**HOW TO CODE FOR PROBE**

**TP137 - NHY10 - 00**

① Plunger Configuration	② Plunger Materials / Finish	③ Spring Force	④ Serial No.
Refer to the following "PLUNGER CONFIGURATIONS"	Standard Specs Y SK + Rh Plated	Standard Specs 10 0.981 N	Tracing No.
	Custom Specs Z SK + Ni Plated	Custom Specs 08 0.750 N ~ 0.849 N	
	C SK + Au Plated	09 0.850 N ~ 0.949 N	
	L BeCu + Ni Plated	10 0.950 N ~ 1.049 N	
	J BeCu + Au Plated	11 1.050 N ~ 1.149 N	
	G BeCu + Rh Plated	12 1.150 N ~ 1.249 N	
	X Others		

**PLUNGER CONFIGURATIONS**

Unit:mm

**NHY10-00**  
(Standard)

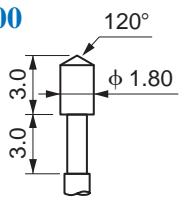

**NUY10-00**  
(Standard)

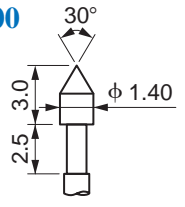

**RHY10-00**  
(Standard)

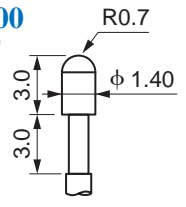

**EHY10-00**  
(Standard)

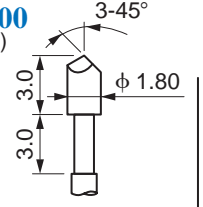

**VHY10-00**  
(Standard)

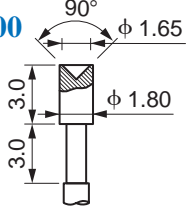

**4WY10-00**  
(Standard)

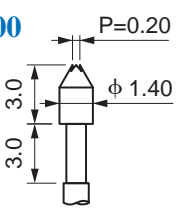

**SHG10-00**  
(Standard)

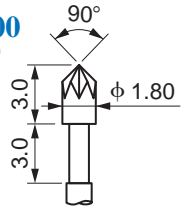

**NBY10-00**  
(Custom)

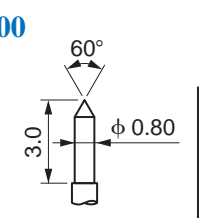

**4HY10-00**  
(Custom)

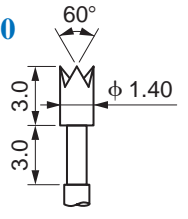

**4BY10-00**  
(Custom)

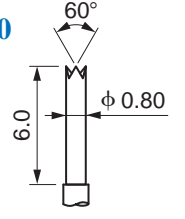

**4TY10-00**  
(Custom)

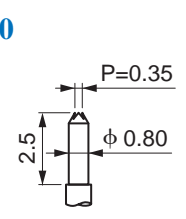

**FHY10-00**  
(Custom)

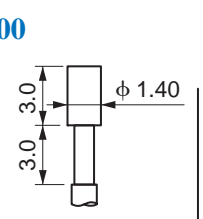

**FWY10-00**  
(Custom)

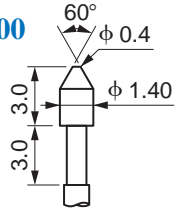

**VWY10-00**  
(Custom)

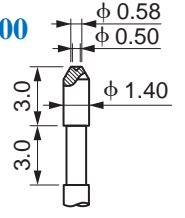

**MHY10-00**  
(Custom)

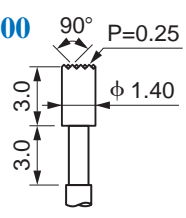

**5HY10-00**  
(Custom)

